

ROSE GOLD BRASS SWAN VANITY SINK FAUCET LUNA FAUCET INSTALLATION INSTRUCTIONS



PRIOR TO INSTALLATION

Please read installation instructions below. All plumbing should be installed in accordance with applicable building codes and regulations.

Unpack and inspect the items for any shipping damages. If you find damages, do not install.

All products must be installed by a professional and certified plumber otherwise warranty may be voided.

POSSIBLE TOOLS REQUIRED*



Plumbers Tape

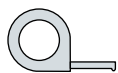

Tape Measure



Level

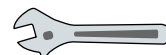

Adjustable Wrench



Hex Wrench



Thread Sealant



Drill



Pencil or Marker



Screwdriver

*not included



Product shown is only for installation display purpose

Faucet Deck Mount Installation

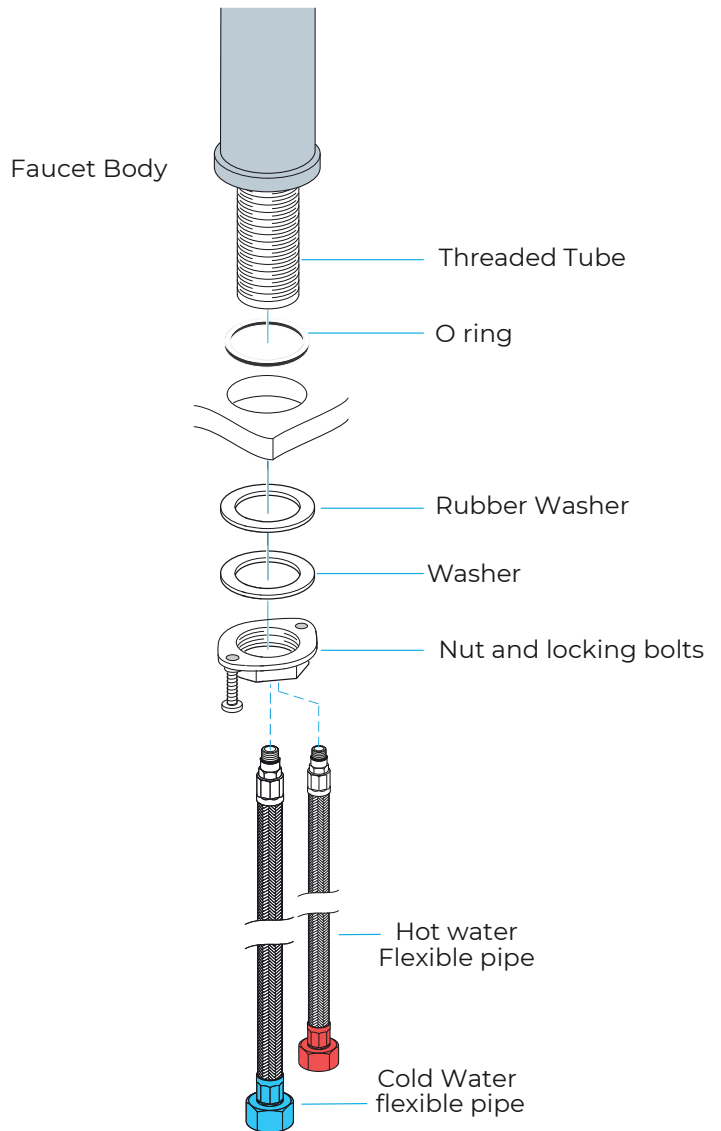
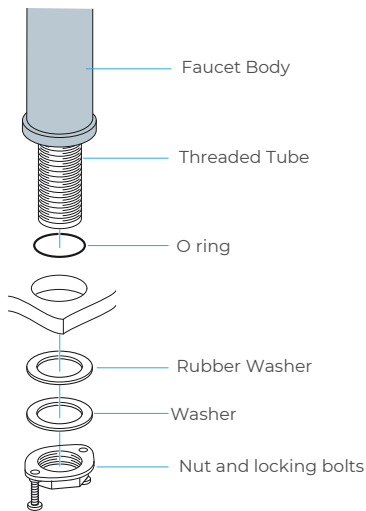

Hole Size Chart

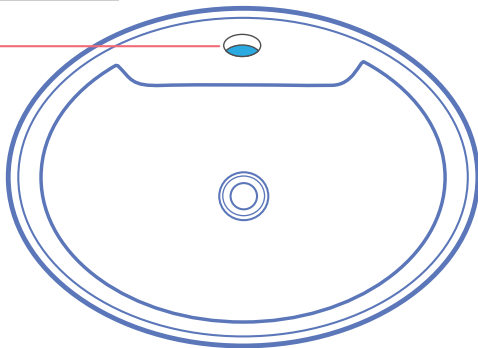

Pre-drilled hole size requirements:



Min: 1.26"/32mm - Max: 1.38"/35mm

Max counter top thickness without deck plate:

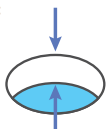

1.38"/35mm

All dimensions and specifications are nominal and may vary. Use actual products for accuracy in critical situations.

Installation Instructions

Step 1:

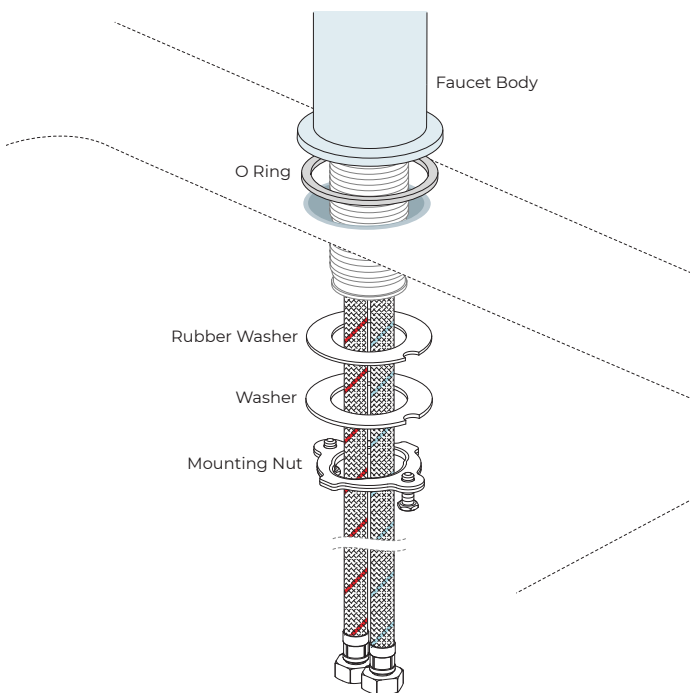

1. Remove the mounting nut, metal washer, and rubber washer from the threaded pipe. Fit the O-ring into the groove of the faucet body. Screw waterlines into the corresponding screw-hole of the faucet body.

Step 2:

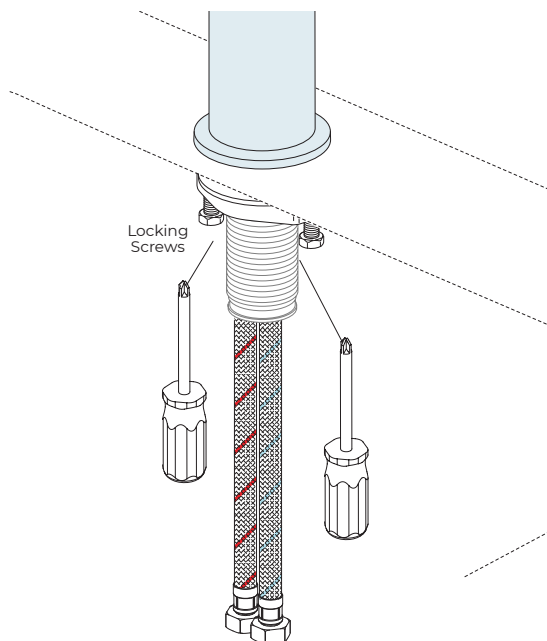

2. Insert waterlines and threaded pipe into the hole of the sink. Install rubber washer, metal washer, and mounting nut back to the threaded pipe. Adjust the faucet body correctly and secure with mounting screws tightly.

Step 3:

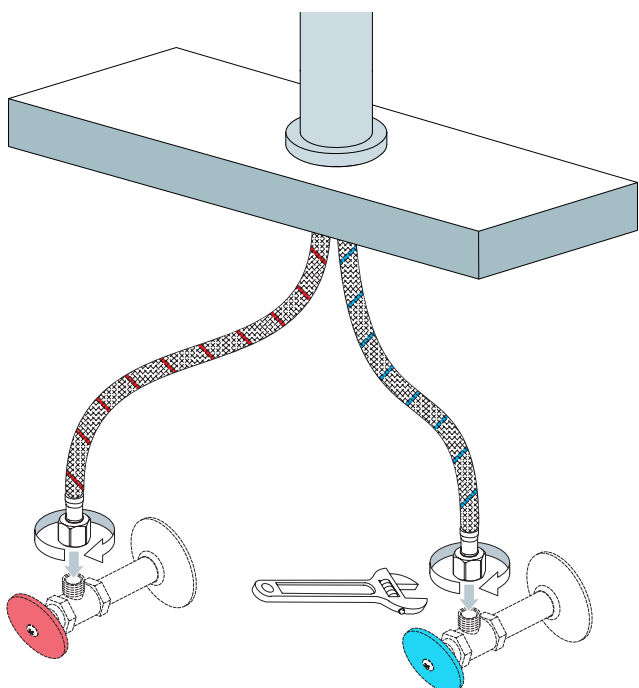

3. Connect waterlines to angle stops. Turn on the angle stops and check for leaks (DO NOT TURN FAUCET ON).

Step 4:

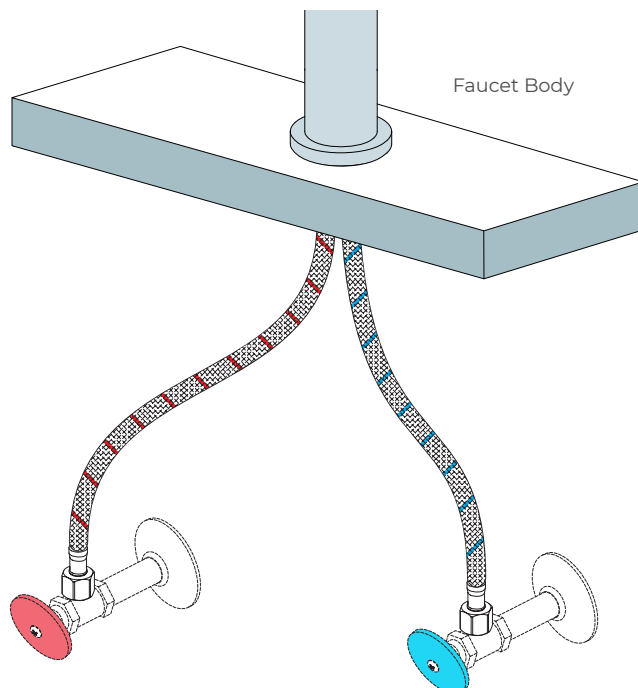

4. Turn faucet on for 1 minute to flush any debris.

Flexible Connecting Hose

Care must be taken when connecting the flexible connection hose from the power supply box to the spout to ensure it does not bend sharply and kink or twist.

See below for recommended ways to fit the flexible connecting hose.

Important: Failure to follow these guidelines may result in poor performance and damage to the flexible connection hose.

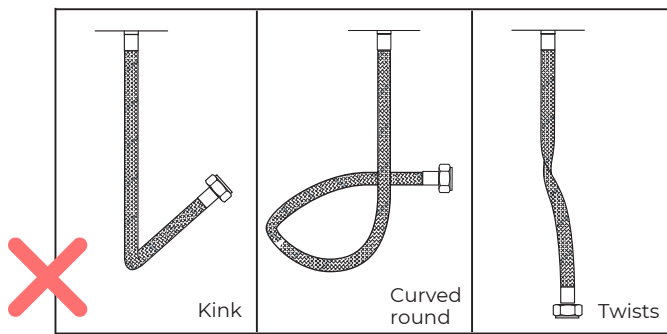
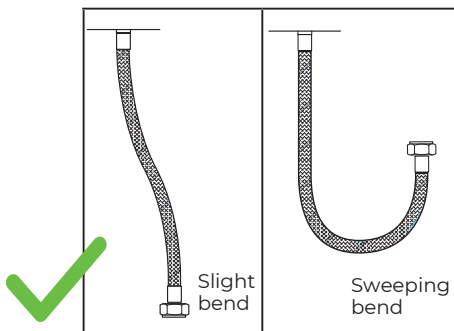

6. If using a spray cleaner, apply the cleaning agent onto a soft cloth, never directly spray onto the product as the cleaner may enter gaps and openings and cause damage. Do not allow the cleaner to remain on the product for a period of time. After cleaning, rinse thoroughly with clean water.

1.



2.

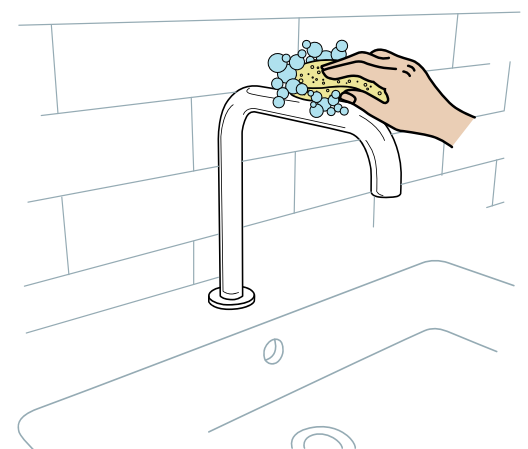

3.

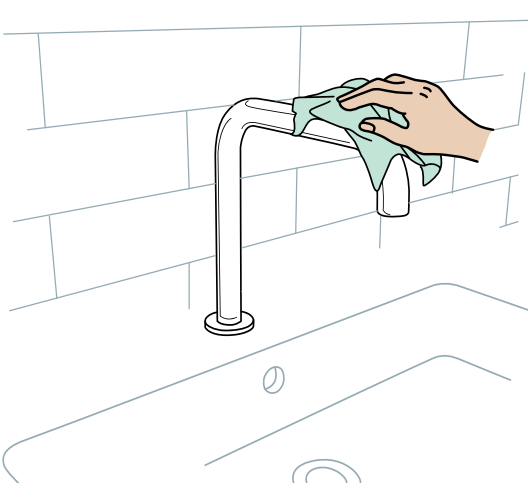

Care & Cleaning

1. The product can be cleaned with warm water, a mild soap and a clean soft cloth.

2. Clean progressively and gently.

3. It is not required to use any abrasive cleaning pads, wire wool or micro-fiber cloths to clean the product.

4. Avoid a vigorous cleaning action, as this could contribute to denaturing and dulling the finish.

5. Abrasive or strong cleaning products containing ammonia, bleaches, alcohol, dyes, acids (hydrochloric, formic, phosphorus, chlorine or acetic) will be detrimental to the product finish.