

FONTANA LUIGI AUTOMATIC INFRARED SENSOR FAUCET WITH TOUCH ACTIVATION IN CHROME INSTALLATION INSTRUCTIONS



BEFORE YOU BEGIN

Before you begin, please read the installation instructions below. Observe all local building and safety codes.

Unpack and inspect the items for any shipping damages. If you find damages, do not install.

Please note all products must be installed by a professional and certified plumber otherwise warranty might be voided.

POSSIBLE TOOLS REQUIRED*



Plumbers Tape



Tape Measure



Level



Adjustable Wrench



Hex Wrench



Thread Sealant



Drill



Pencil or Marker



Screwdriver

*not included

Technical Information

Water Consumption: 0.05Mpa-0.6Mpa
 Detection Zone: 16-32 cm or adjustable
 Motor valve lifespan: up to 500000 flushes
 Battery lifespan: 100000 cycles
 Static Power Consumption: 0.36mw
 Working Power consumption: 0.5mw
 Inductive Opening Time: < 1 second
 Inductive Closing Time: < 2 second
 Dia.of inlet / outlet pipe: G1/2"
 Flux: $\geq 0.07\text{L/S}$
 Temperature: 0.1-50°C

Faucet Size

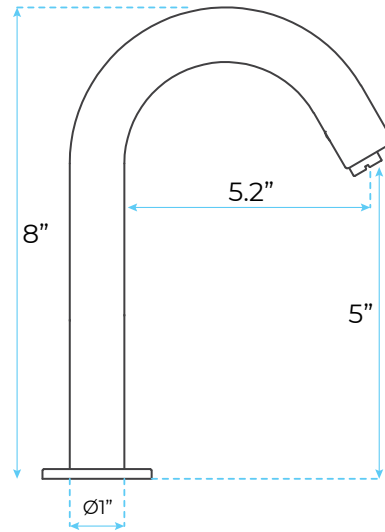

Faucet Deck Mount Installation



Hole Size Chart

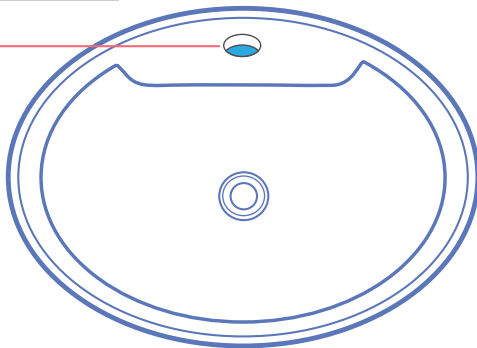

Pre-drilled hole size requirements:



Min: 1.26"/32mm - Max: 1.38"/35mm

Max counter top thickness without deck plate:

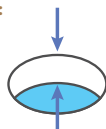

1.38"/35mm



All dimensions and specifications are nominal and may vary. Use actual products for accuracy in critical situations.

Installation Instructions

STEP 1:

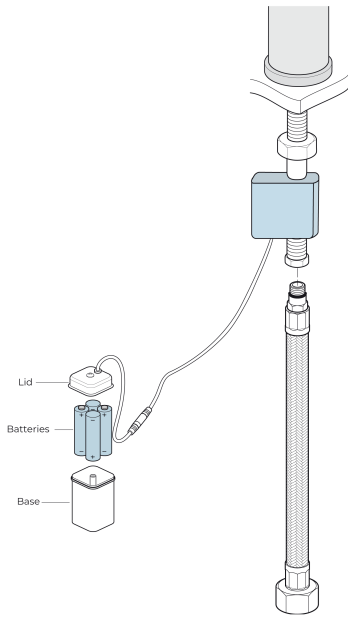

STEP 2:

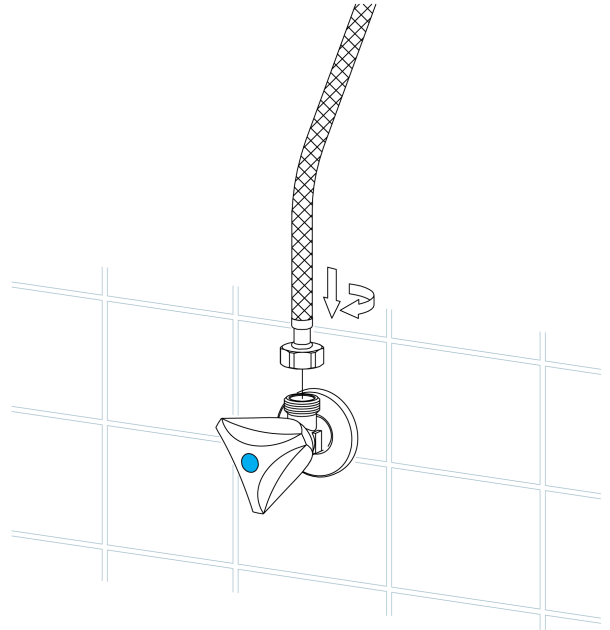

STEP 3:

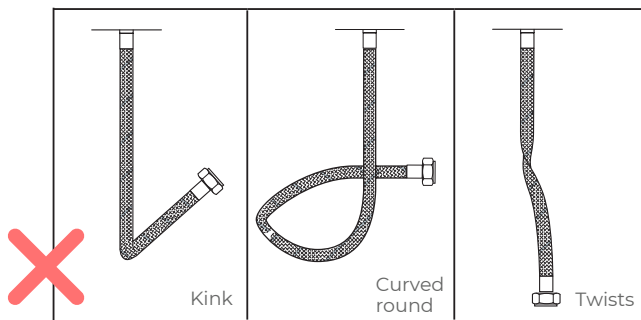
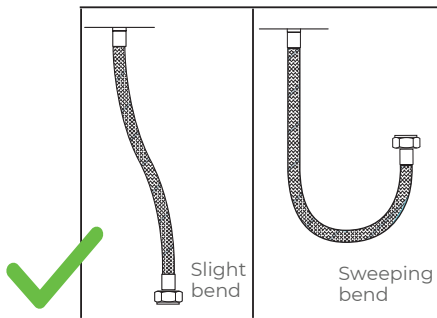

Easy to install



The rubber ring makes the faucet waterproof and firmer

Fontana Showers®

1. Screw the hose into the corresponding screw-hole of the faucet body. Fix the o-ring into the bottom groove of the faucet body.
2. Insert hose, threaded pipe and data cable through the drilled hole of the countertop. Put rubber washer and metal washer onto the threaded pipe, screwing in mounting nut. Adjust the faucet body correctly and tighten the mounting nut with screws.
3. Install the control box to the faucet.
4. Then connect the battery cable to the control box.
5. Make Connections to water supplies. Turn on the water supply and flush water lines into a container for one minute.
Important: This flushes away any debris that could cause damage to internal parts.
6. Connect waterlines to angle stops. Turn on the angle stops and check for leaks (DO NOT TURN FAUCET ON).
7. Turn the faucet on for 1 minute to flush any debris.

Flexible Connecting Hose

Care must be taken when connecting the flexible connection hose from the power supply box to the spout to ensure it does not bend sharply and kink or twist. See above for recommended ways to fit the flexible connecting hose.

Important: Failure to follow these guidelines may result in poor performance and damage to the flexible connection hose.

UNIQUE DESIGN

Personality design, decorate life

Strong toughness, not easy to damageStrong toughness, not easy to damageStrong toughness, not easy to damageStrong toughness, not easy to damageStrong toughness, not easy to damage



PATENTED TECHNOLOGY
MATERIAL ANTI-OXIDATION
CORROSION RESISTANCE



ANTI-FOULING

Anti-fouling, easy to clean

Strong toughness, not easy to damageStrong toughness, not easy to damageStrong toughness, not easy to damageStrong toughness, not easy to damageStrong toughness, not easy to damage

STRONG TOUGHNESS

Strong toughness, not easy to damage

Strong toughness, not easy to damageStrong toughness, not easy to damageStrong toughness, not easy to damageStrong toughness, not easy to damageStrong toughness, not easy to damage



Sensor Range

This machine can automatically adjust the inductive range within 10 seconds of electrification. Don't use inductor during this period in order for the inductor to automatically adjust to a suitable inductive range.

Set Water Flow Time-Out

The machine will shut off the water when washing time exceeds 1.5 minutes foreign matter induces continuously in inductive areal. If follow-up washing is needed, re-induce after removing hands for 2 seconds.

Notes

1. Please use the AA type alkaline battery (1.5v for each).
2. Fix the battery correctly. Should not be mix use the batteries with different brands, the new and old and if use non-alkaline battery, the battery life is short in 1-2 months.
3. After installation of the battery, the solenoid valve will do its self-testing.
4. After providing the power, in 10sec, the machine will self adjust the sensor distance, so during this period, do not make it work.
5. If the sensor distance is short, please move away the barrier for 5-6 mins, the machine will adjust to normal.
6. If the sensor distance from far to near, and water flows continuously, the machine will self-adjust the distance after 5 mins.



Incorrect Installation

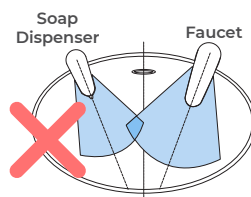

Keep sensor range adjustment within 4 inches away from center of spout. This can only be done with optional remote control.

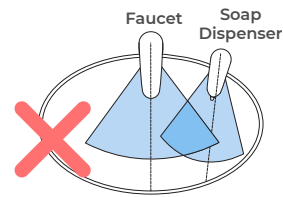

Installing electronic soap dispenser & faucet with intersecting centerline might lead to accidental activation of either or both.

Correct Installation

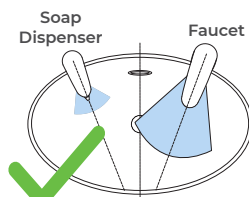

Keep sensor ranges factory preset.

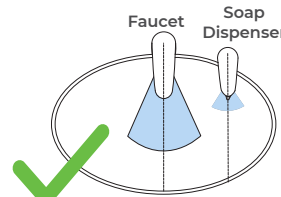

Keep soap spout & faucet centerline parallel.

General Information

Our sensor spouts have a non-touch control which uses infrared sensing technology to detect human presence. Once detected, the spout instantly dispenses water and automatically stops once the user moves their hands away to eliminate unnecessary water wastage, whilst creating a more hygienic washroom solution.

All products manufactured and supplied by Fontana are safe and comply to legislative requirements. Providing they are installed correctly and receive regular maintenance in accordance with these instructions your user experience will not be affected.

Battery Override

In the event of a power failure, the product will automatically switch to battery operated mode to ensure the spout continues to function. The tap can also operate on the battery alone if no mains power source is available.

Hygienic

The proximity sensor removes the need to touch the spout body, reducing the spread of germs and reducing the chance of cross infection.

For more details, visit the product page:

