

BRAVAT DARK OIL RUBBED BRONZE SHOWER SET WITH VALVE MIXER 2-WAY CONCEALED CEILING MOUNTED SPECIFICATIONS

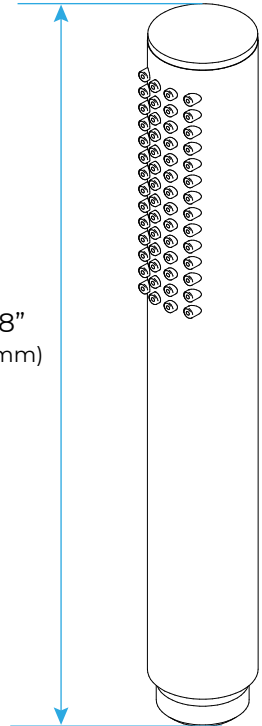

Hand Shower

The minimum required water pressure is 0.05 MPa (0.5 bar).
Flow rate 2.5 GPM (9.5 LPM).



7.68"
(195 mm)

Shower Head

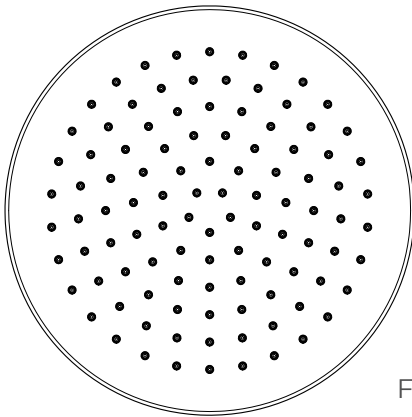

8/10/12/16/20 inch

Available in multiple sizes

1/2" NPT inlets
Easy clean nozzles
Flow Rate: 9.5L/min 2.5 GPM

No tools required, G1/2" connector fits standard sized shower plumbing.

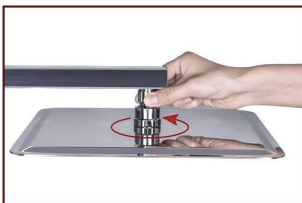

✓ Use your hands counterclockwise to unscrew the old showerhead and removed it.



✓ Take out the Hiendure Showerhead, make sure the shower filter is placed in the connector.

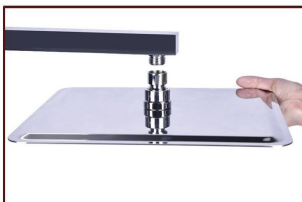

✓ Ensure the showerhead full horizontal alignment wall mounted shower arm thread

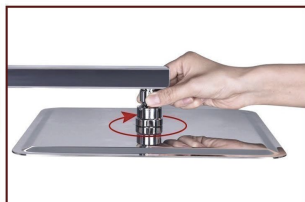

✓ Use your heads clockwise to tighten showerhead.

All dimensions and specifications are nominal and may vary. Use actual products for accuracy in critical situations.

Shower Mixer

This technical product information is exclusively for the installer or trained specialists.

Application: Operation with unpressurized storage heaters is not possible. Use for indoor public places and common residence.

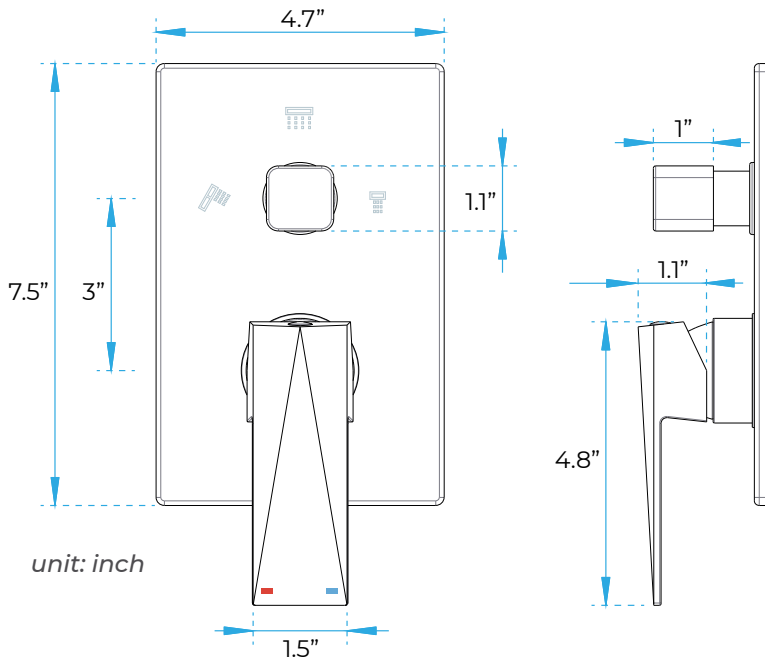

Specifications

Flow pressure: min. 0.5 bar
recommended 1 – 5 bar

Operating pressure: max. 10 bar

Test pressure: 16 bar

Flow rate at 3 bar flow pressure

for bath: ≥ 19.8 L/min

for shower: ≥ 12 L/min

Hot water inlet temperature: max. 80°C

Recommended (energy saving): 60°C

Environment temperature: 5°C~45°C

If static pressure exceeds 5 bar, a pressure-reducing valve must be fitted.
Avoid major pressure differences between hot and cold water supply.

Shower Mixer Connections

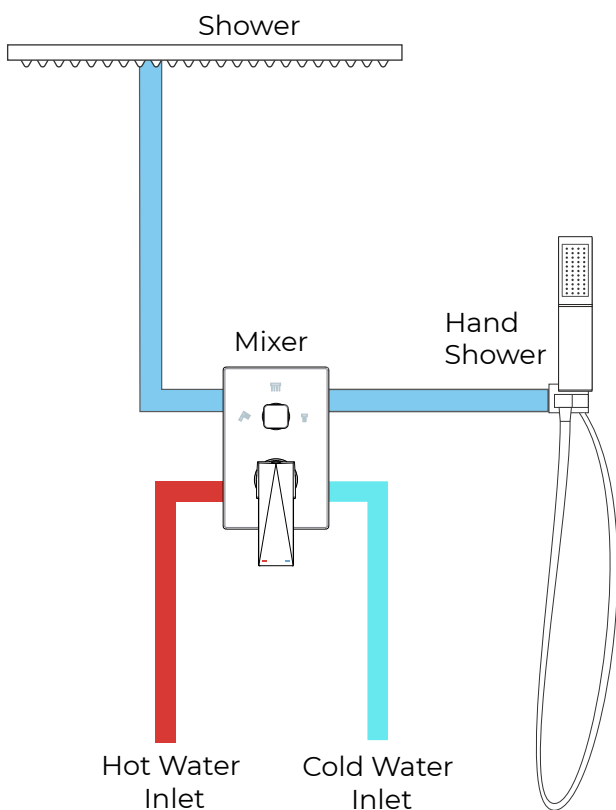

Installation:

Flush piping system prior and after installation of fitting thoroughly!

Fitting a temperature limiter is possible.



Function:

Check connections for leaks and check function of fitting.

Flow is diverted automatically from shower outlet to bath inlet when the fitting is closed.



Maintenance:

Inspect and clean all components and replace if necessary.

Shut off water supply for maintenance work.



When installing the cartridge, ensure that the seals are correctly seated.

Tighten the screws evenly and alternately.