

COMMERCIAL ELECTRONIC SENSOR AUTOMATIC TOUCHLESS SOAP DISPENSER INSTALLATION INSTRUCTIONS



PRIOR TO INSTALLATION

Please read installation instructions below. All plumbing should be installed in accordance with applicable building codes and regulations.

Unpack and inspect the items for any shipping damages. If you find damages, do not install.

All products must be installed by a professional and certified plumber otherwise warranty may be voided.

POSSIBLE TOOLS REQUIRED*



Plumbers Tape



Tape Measure



Level

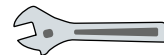

Adjustable Wrench



Hex Wrench



Thread Sealant



Drill



Pencil or Marker



Screwdriver

*not included

Deck Mount Installation

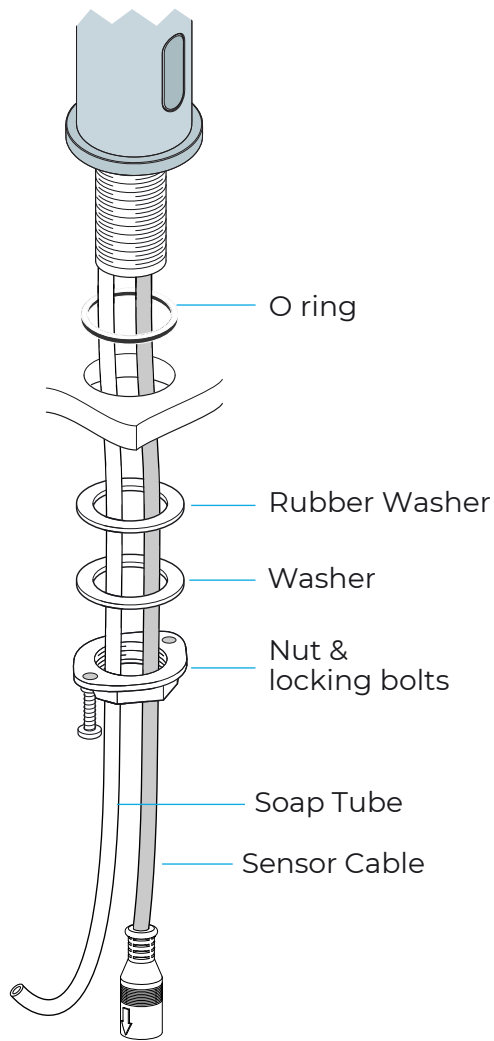

Installation Overview

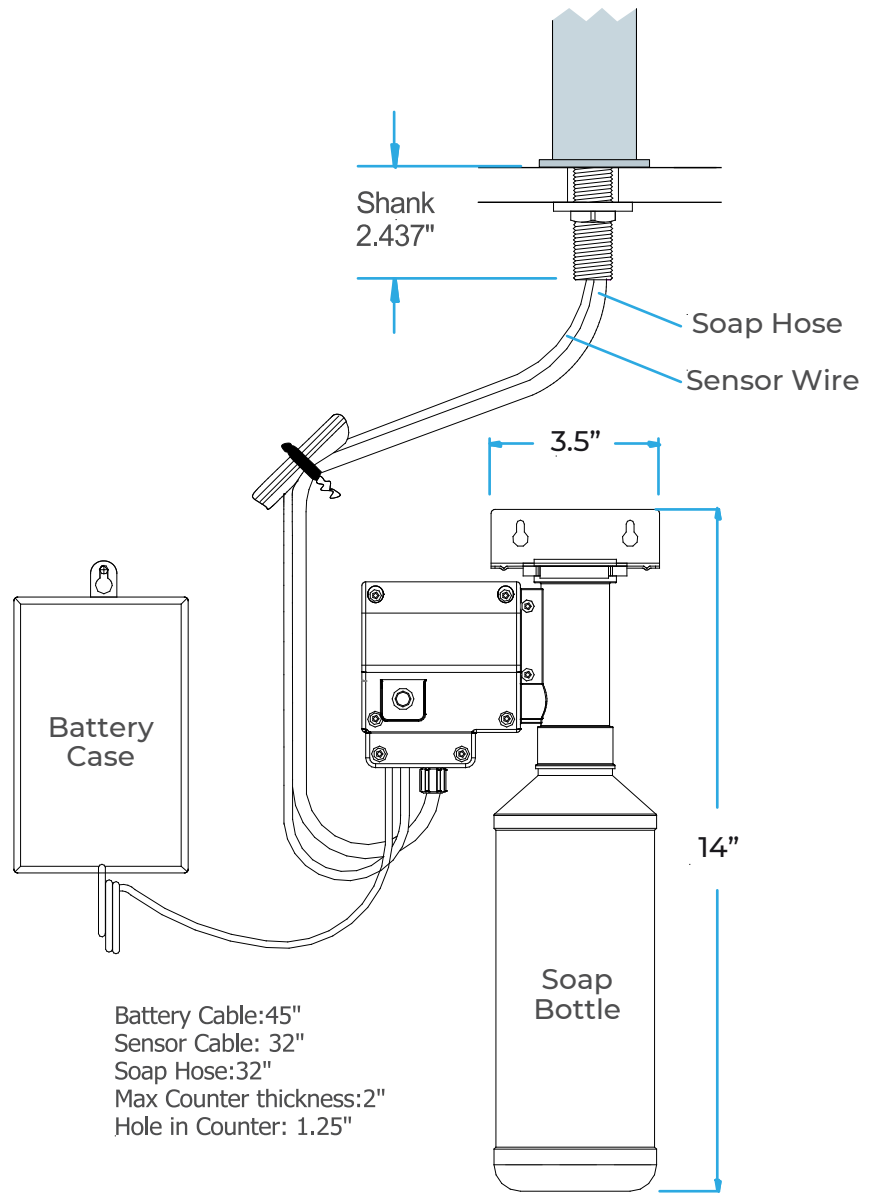

Rough-in

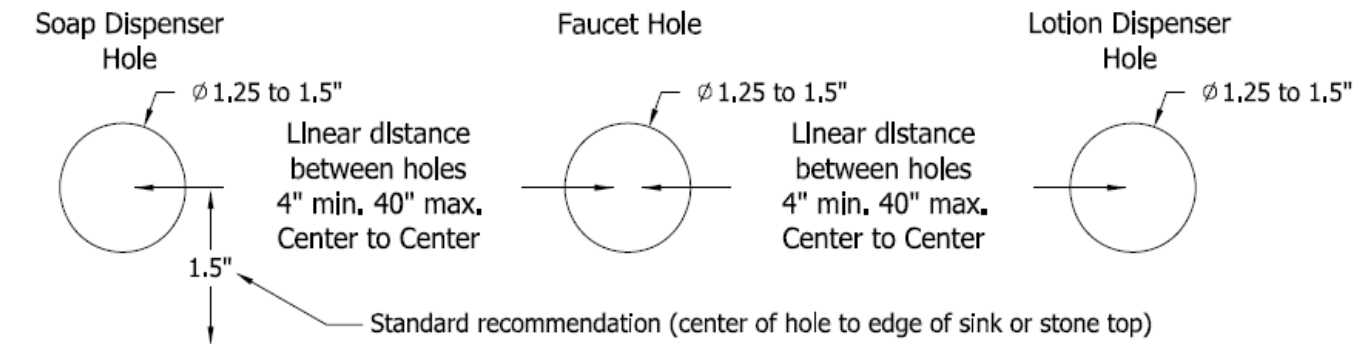

*** Maximum Counter top thickness 2" ***

All dimensions and specifications are nominal and may vary. Use actual products for accuracy in critical situations.

Installation of Soap Bottle

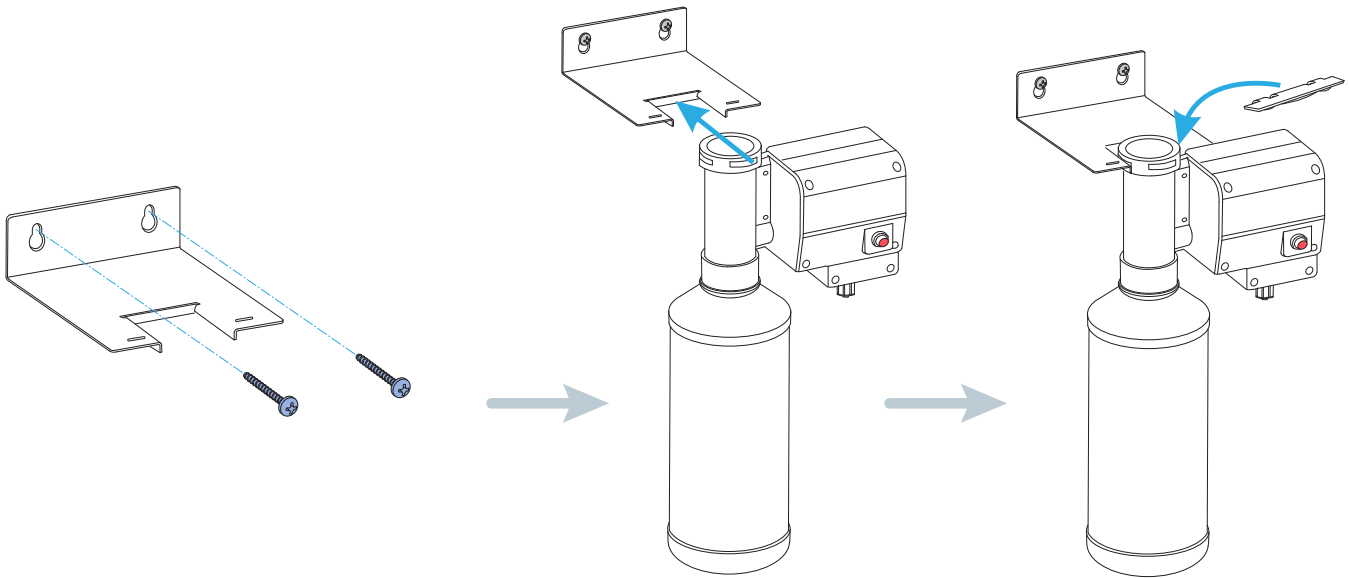

Install the bracket on the wall

Insert the pump onto the bracket

Insert the locking plate into bracket

Soap Refill Process

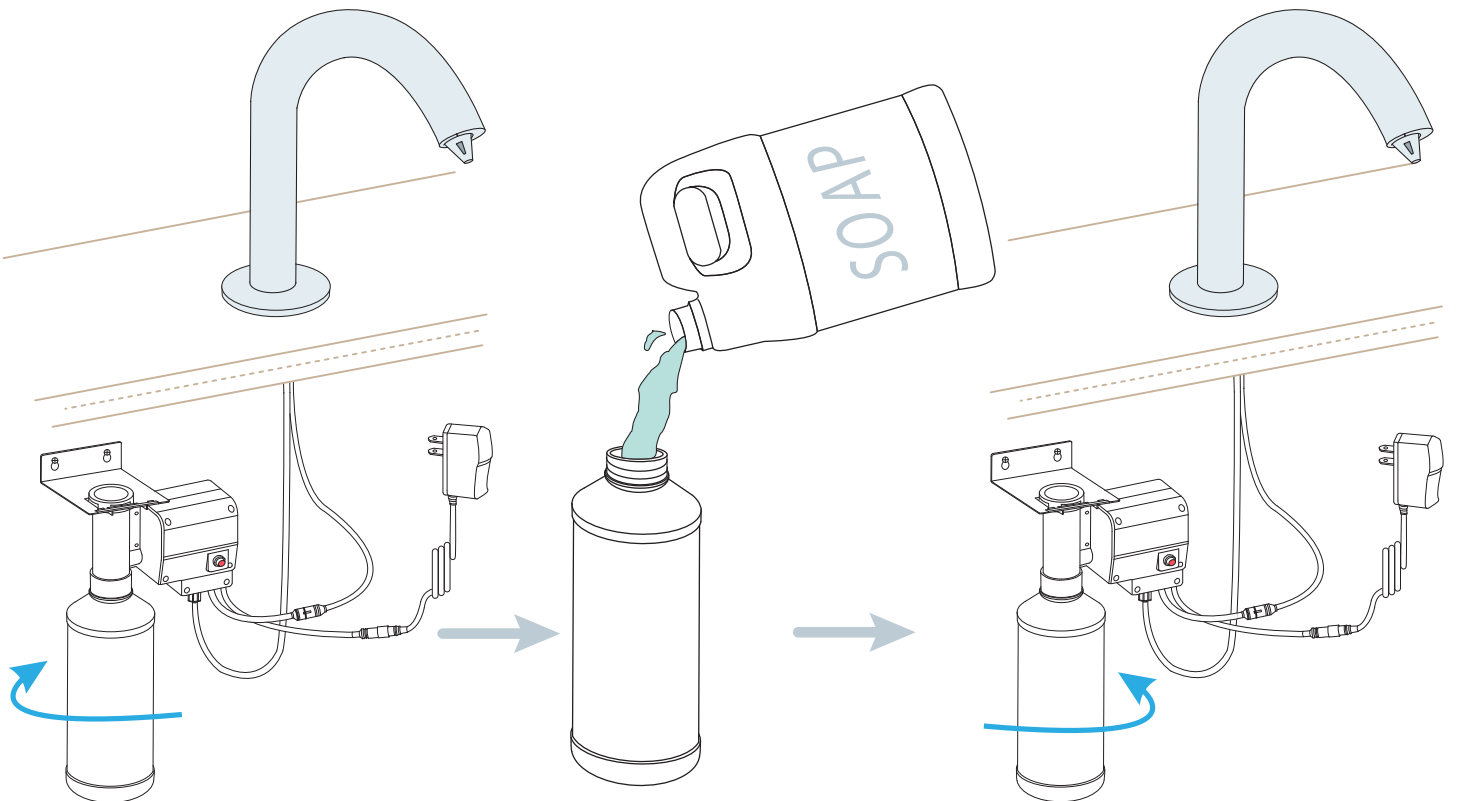

Unscrew the empty bottle.

Add soap into the empty bottle.

Affix the bottle with full soap onto the pump, and do not over tighten.

Deck Mounted Faucet

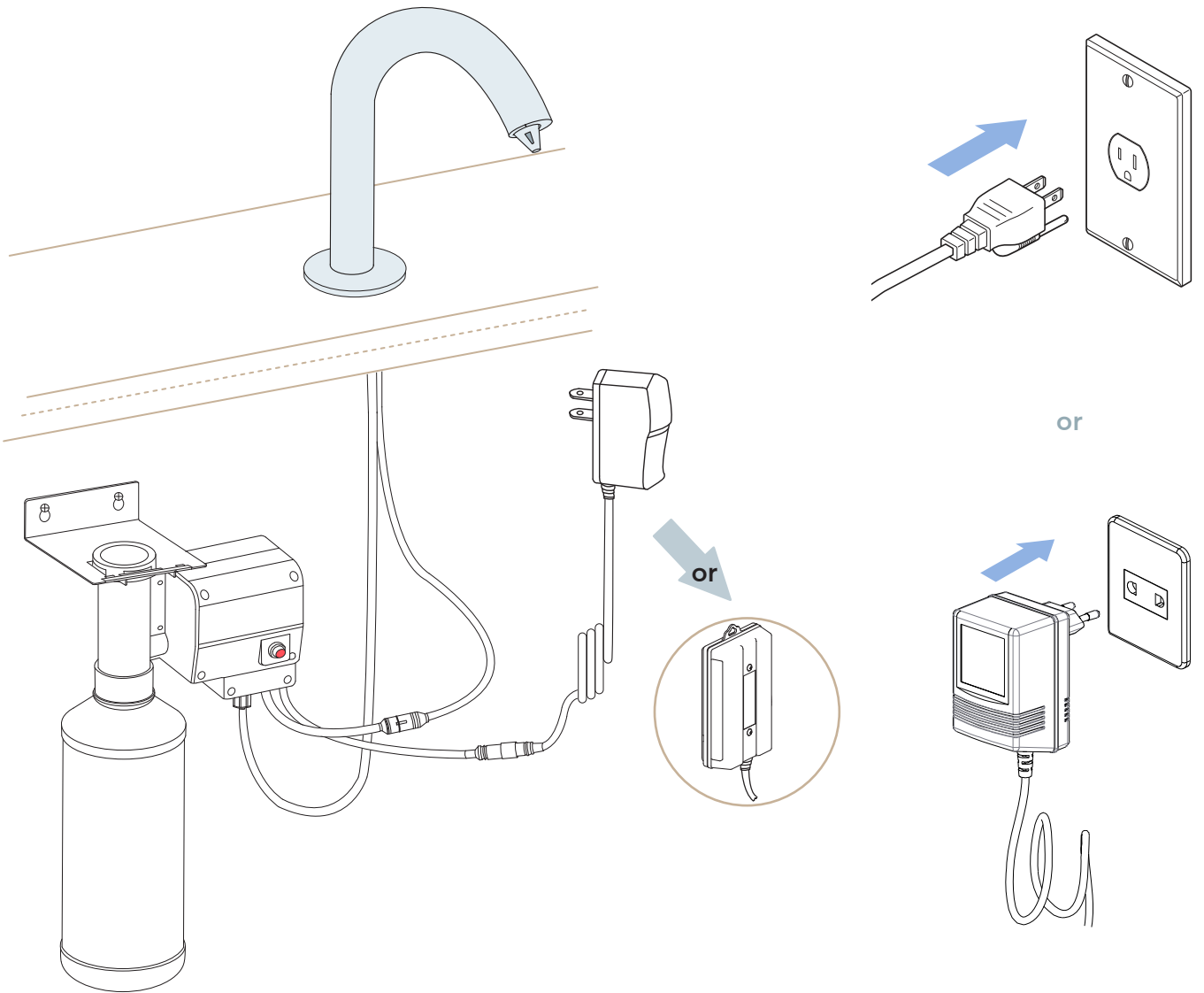

Battery Box

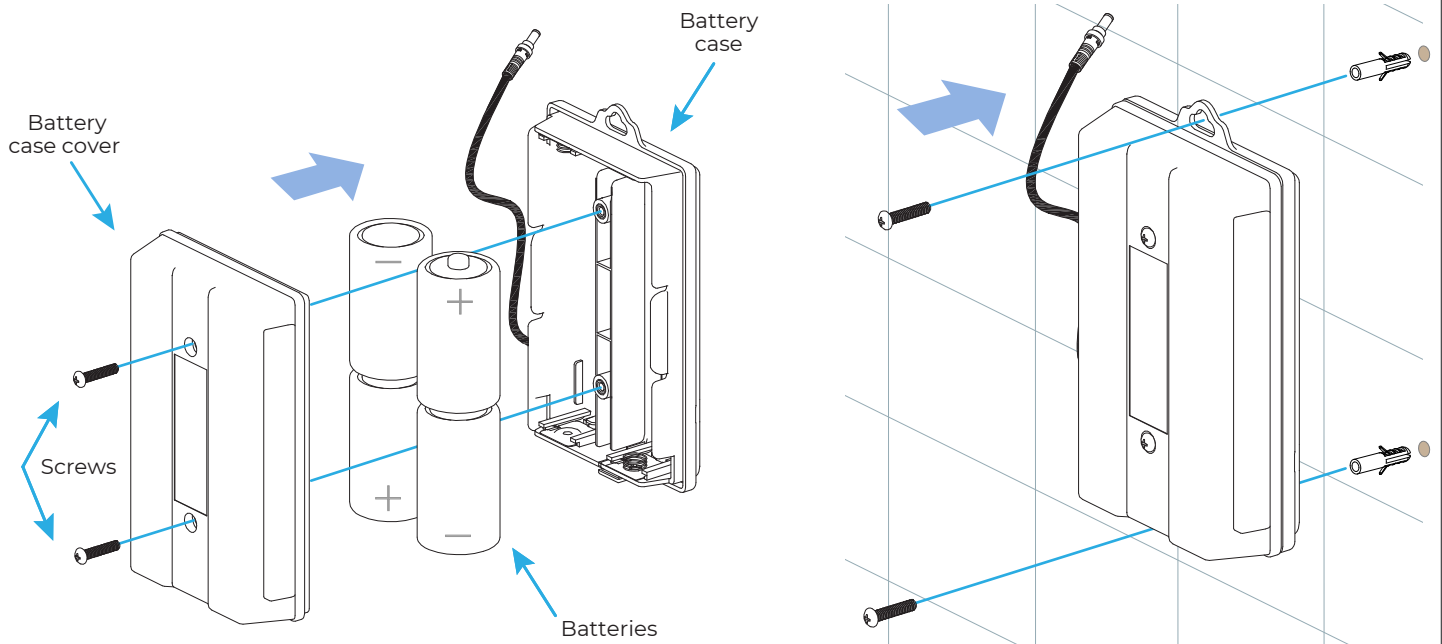

1. Remove cover of battery case.
 2. Install four (4) D size alkaline batteries.
 - Note: Make sure the batteries are installed in correct orientation (polarity).
 3. Replace battery case cover.
 4. Tighten screws.
- The standard life cycle time is 2 years, based on average use 2000 times/month.

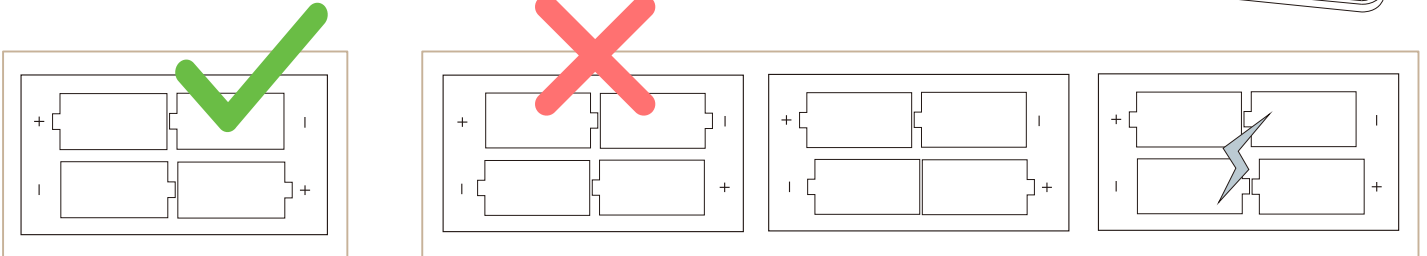
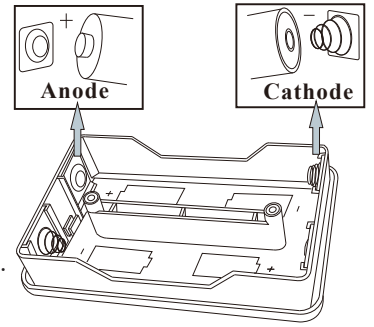

Usage

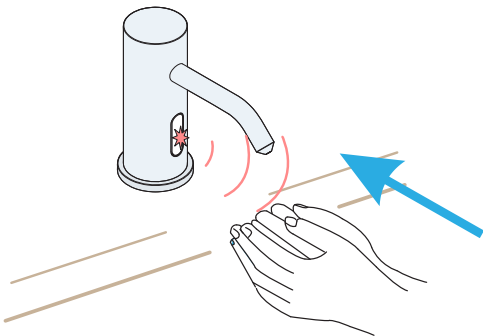

Place hands immediately under soap spout.

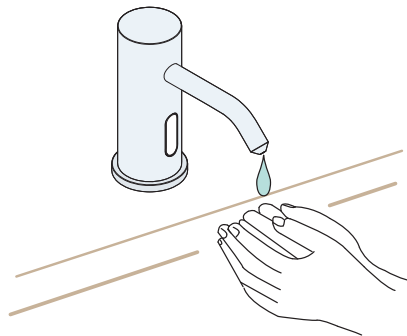

Predetermined amount of soap will dispense

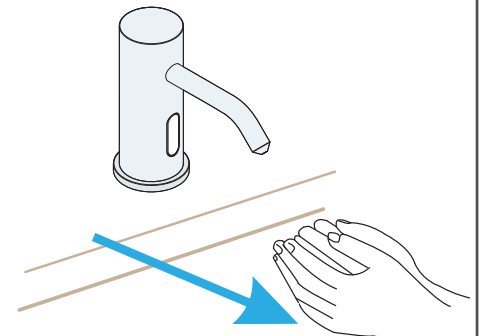

If more soap is needed, remove hands & repeat.

Usage of Button

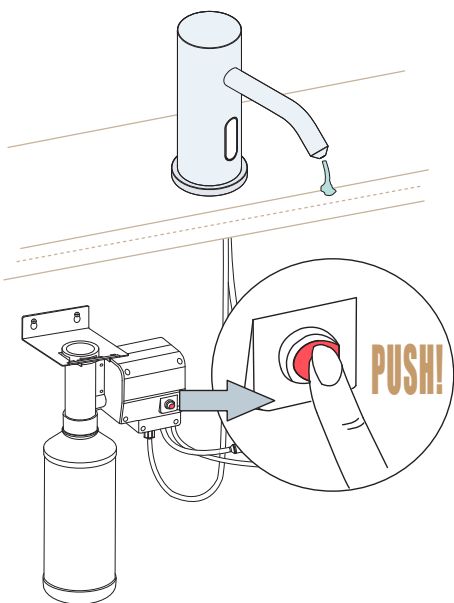

When the soap bottle is filled with soap, press the button till soap dispenses out of nozzle.

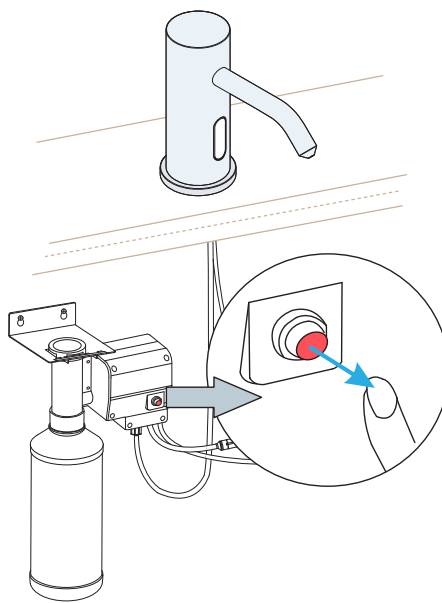

Do not use the sensor when the button is pressed, because they cannot be used at the same time, as it might lead to the damage to the machine.

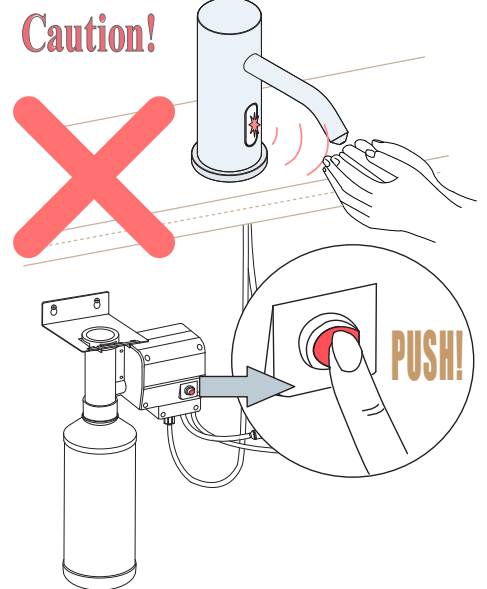

Commissioning Sequence

Before using the soap dispenser for the first time, the following sequence must be carried out.

- Fill the bottle full of soap.
- Locate the dispense button on the side of the pump. Press and hold the button until soap is dispensed from the spout. This will ensure the dispenser tube and cable are full of soap.

Operation

Place your hand under the spout within the sensing range.

Once the your hand is detected, a small amount of soap will be dispensed from the spout into your hand.

General Information

Our sensor spouts have a non-touch control which uses infrared sensing technology to detect human presence. Once detected, the spout instantly dispenses soap and automatically stops once the user moves their hands away to eliminate unnecessary soap wastage, whilst creating a more hygienic washroom solution.

All products manufactured and supplied by Fontana are safe and comply to legislative requirements. Providing they are installed correctly and receive regular maintenance in accordance with these instructions your user experience will not be affected.

Sensor Faucet & Soap Dispenser Installation

Incorrect Placement

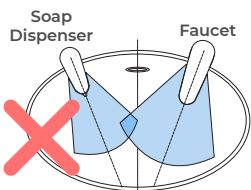

Keep sensor range adjustment within 4 inches away from center of spout. This can only be done with optional remote control.

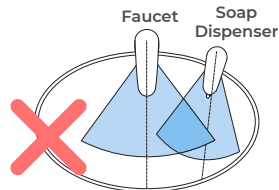

Installing electronic soap dispenser & faucet with intersecting centerline might lead to accidental activation of either or both.

Correct Placement

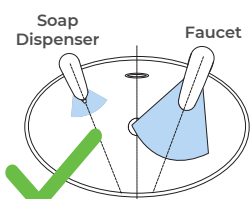

Keep sensor ranges factory preset.

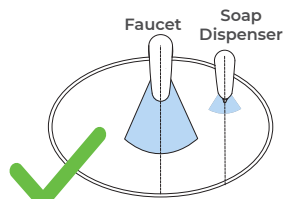

Keep soap spout & faucet centerline parallel.

Care & Cleaning

- Always wipe your fixture down with a soft cloth after each use to prevent mineral build-up and water-spotting. Should spotting occur, remove water spots with warm water and a soft, damp cloth.
- Wipe away any debris adhering to the spout or sensor.
- Wipe away debris with a damp cloth containing a suitable amount of a neutral, dishwashing detergent. Then wipe clean with a damp cloth.
- When cleaning around the sensor, please be careful not to scratch the surface of the sensor window.
- Do not use detergent that might damage the surface of spout. These include:
 - Detergents containing acid, chlorine bleach or alkali.
 - Detergents that are coarse granules in nature, such as polishing powder.
 - Solvents such as paint thinner or benzene.
 - Abrasive aids such as nylon scrubbers/brushes, steel wool, etc.

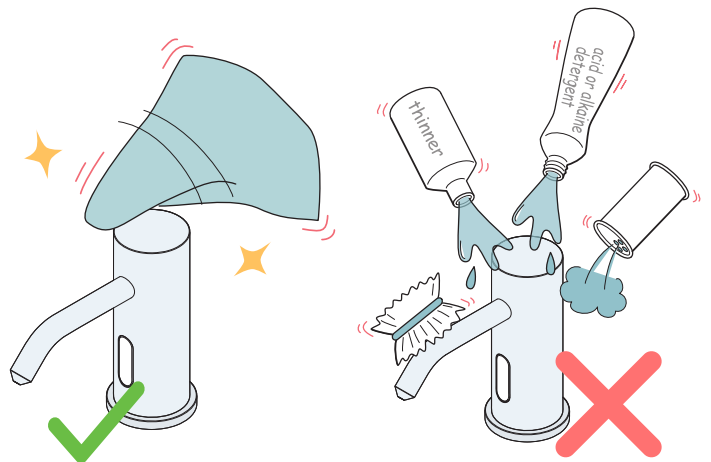

Hygienic

The proximity sensor faucet removes the need to touch the faucet body, reducing the spread of germs and the chance of cross-contamination.